

WILDWOOD TV LIFT FURNITURE TV BED INSTALLATION INSTRUCTIONS

BOOKLET #1
For all standard TV Beds
Deluxe Mechanism

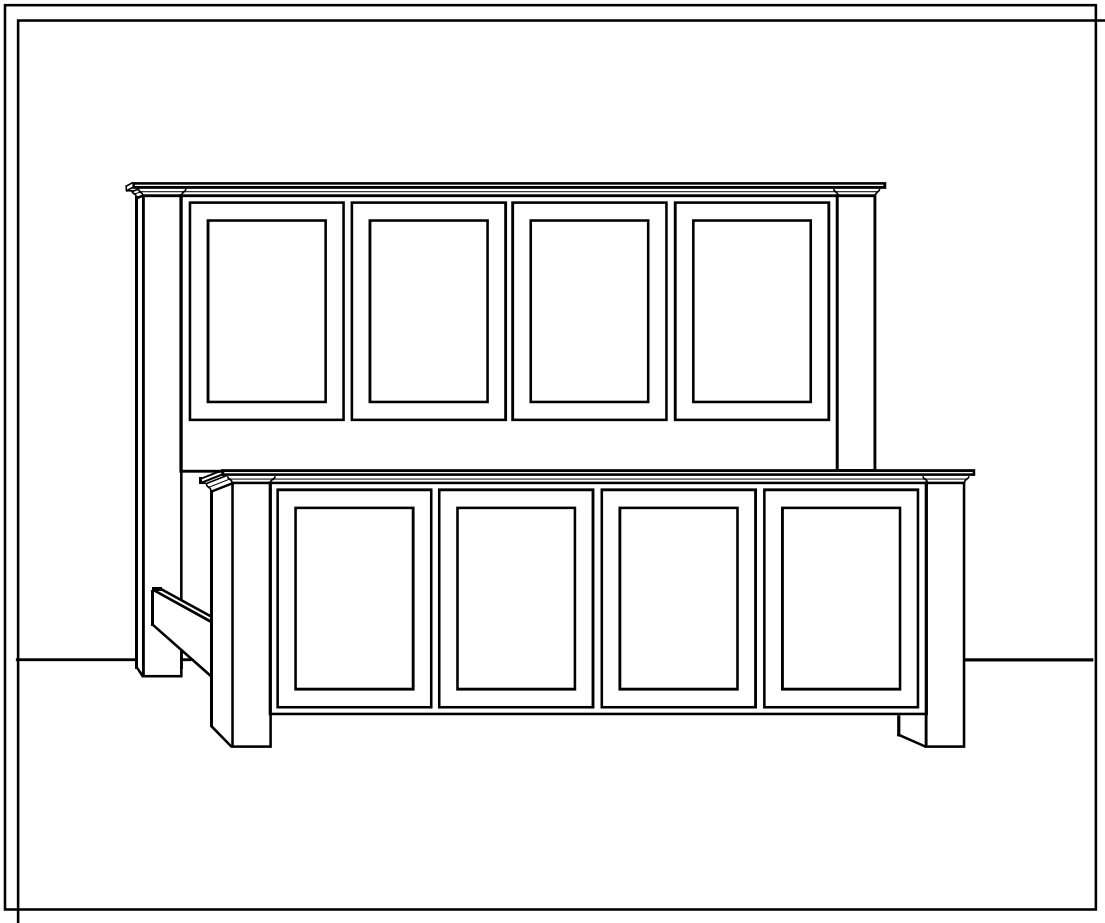

Wildwood
TV LIFT FURNITURE

— Getting To Know Your TV Bed's Components —

Headboard

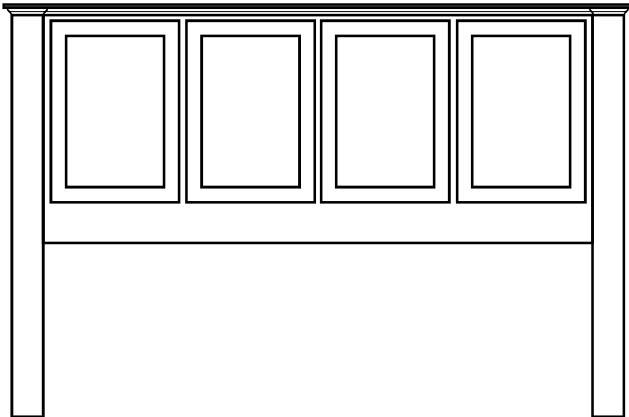

TV Lift Footboard

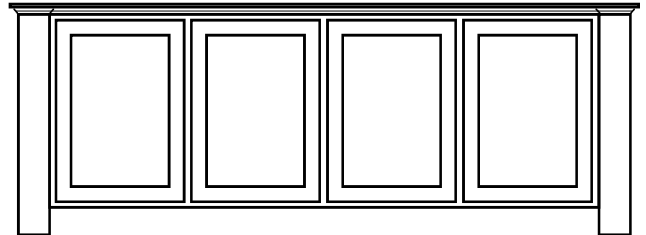

6" Side rails
(Connects the headboard to the footboard)



TV Lift Mechanism

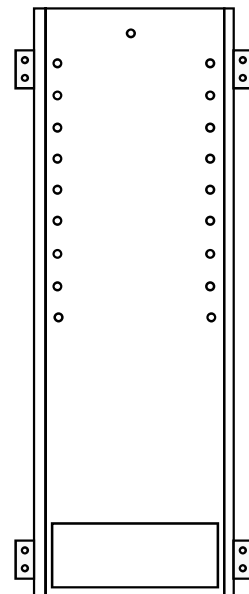

Remote

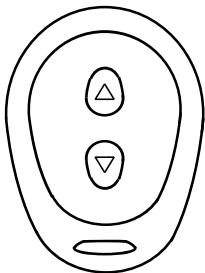

Rocker Switch

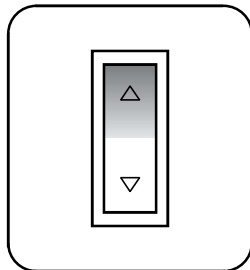

**Not shown here is the hardware box, which should include:

- All of the hardware shown on pg. 2
- TV lift mechanism arms (necessary for *some* TV models)

— Hardware Included —

3/4" Wood Screws
Qty: 4

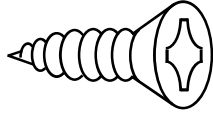

3/8" Spacer
Qty: 4

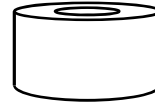

1/2" TV Mounting Bolts
Qty: 4

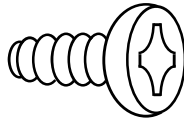

3/4" Spacer
Qty: 4

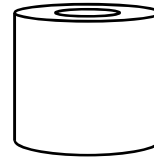

1 1/8" TV Mounting Bolts
Qty: 4

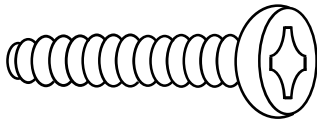

3/4" TV Mounting Bolts
Qty: 4

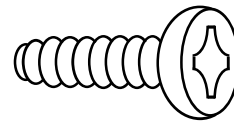

1 1/2" TV Mounting Bolts
Qty: 4

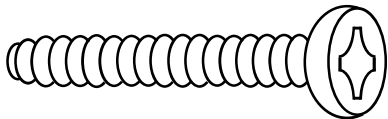

5/8" Machine Screws
Qty: 8

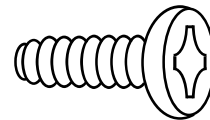

5/8" Wood Screws
Qty: 2

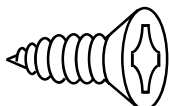

Step 1:

Position the headboard and TV lift footboard approximately where you would like them to be positioned in your room.

Note that the headboard and footboard are not stable on their own, and will need to be stabilized

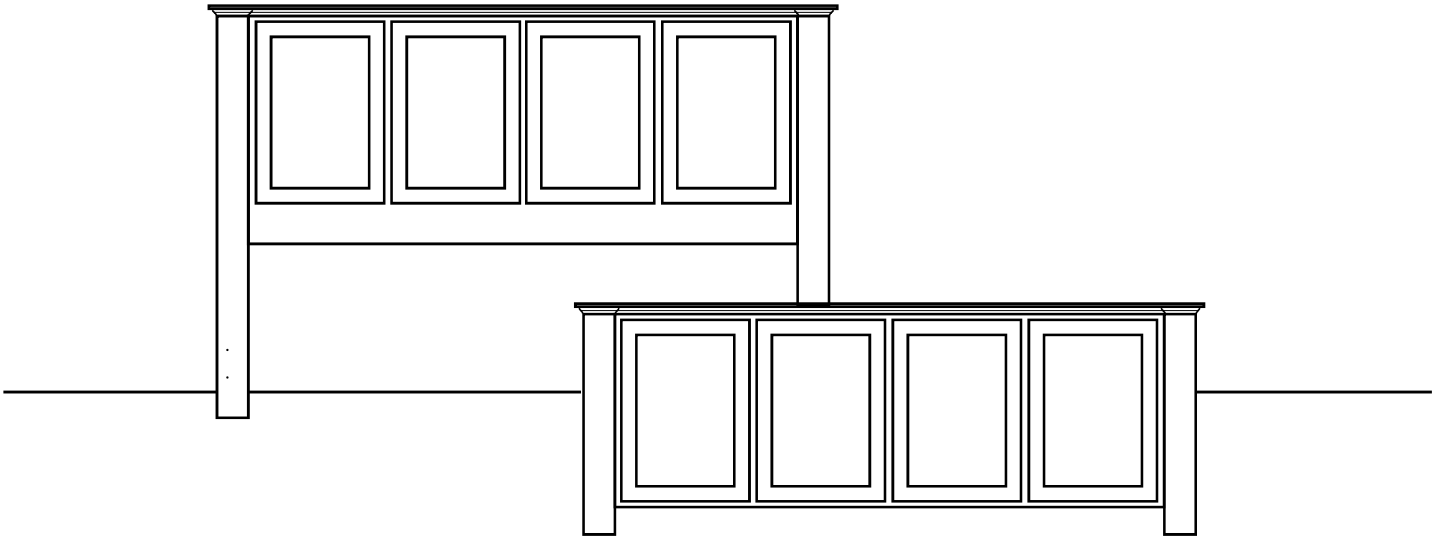

Step 2:

Attach side rails to headboard and footboard using steel bed fittings.

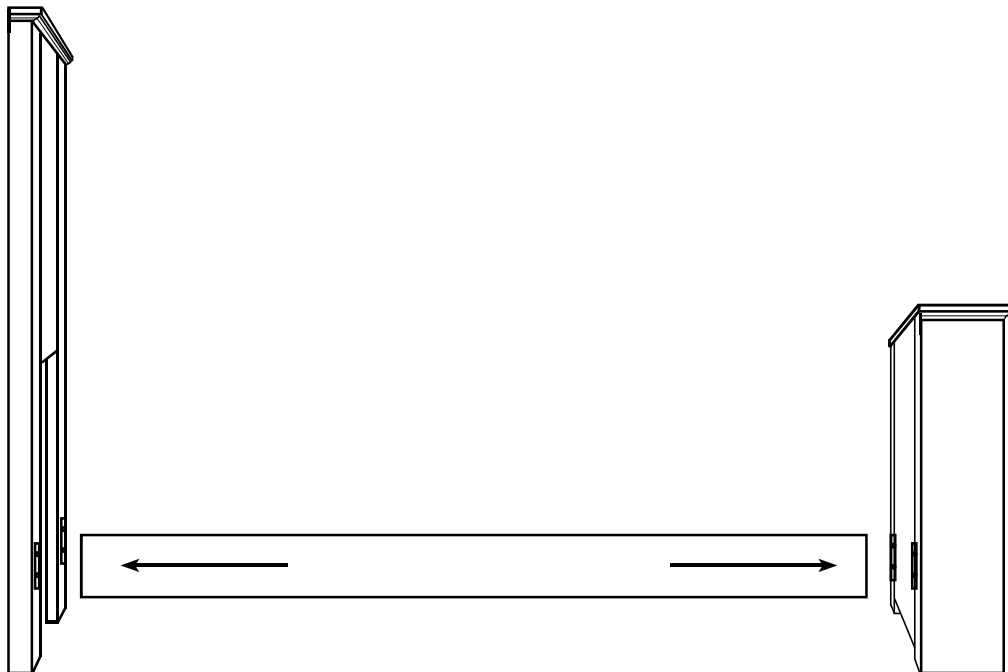

Step 3:

Secure each steel side rail fittings using 3/4" wood screws

Tools Needed:

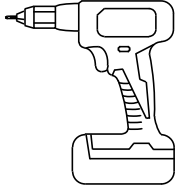

Materials Needed:

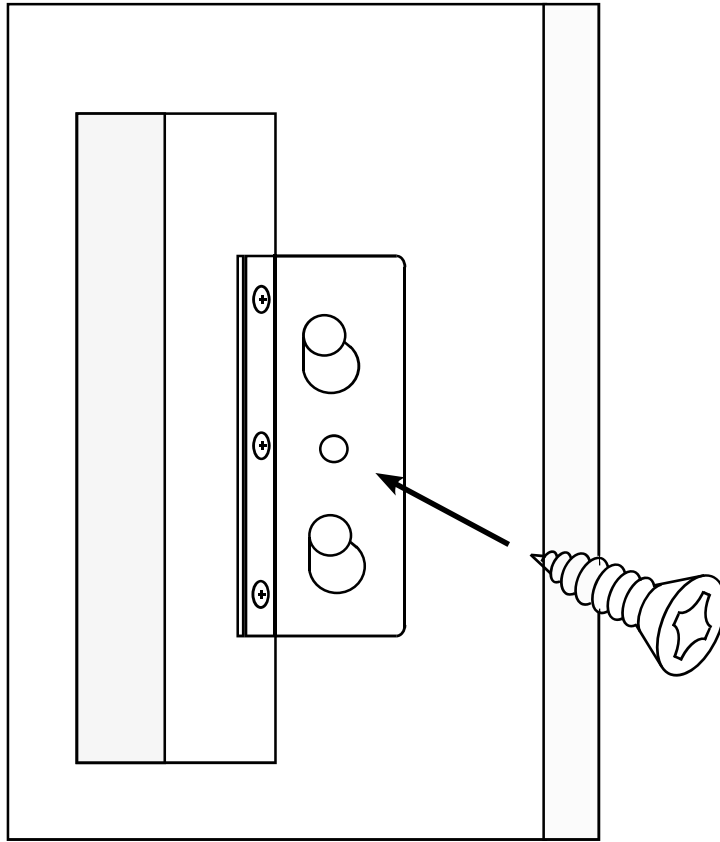
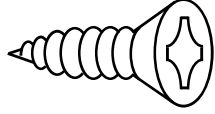

3/4" Wood Screws



Step 4:

Using a 4mm allen wrench, remove the top two screws securing the mechanism mounting board and remove from the footboard.

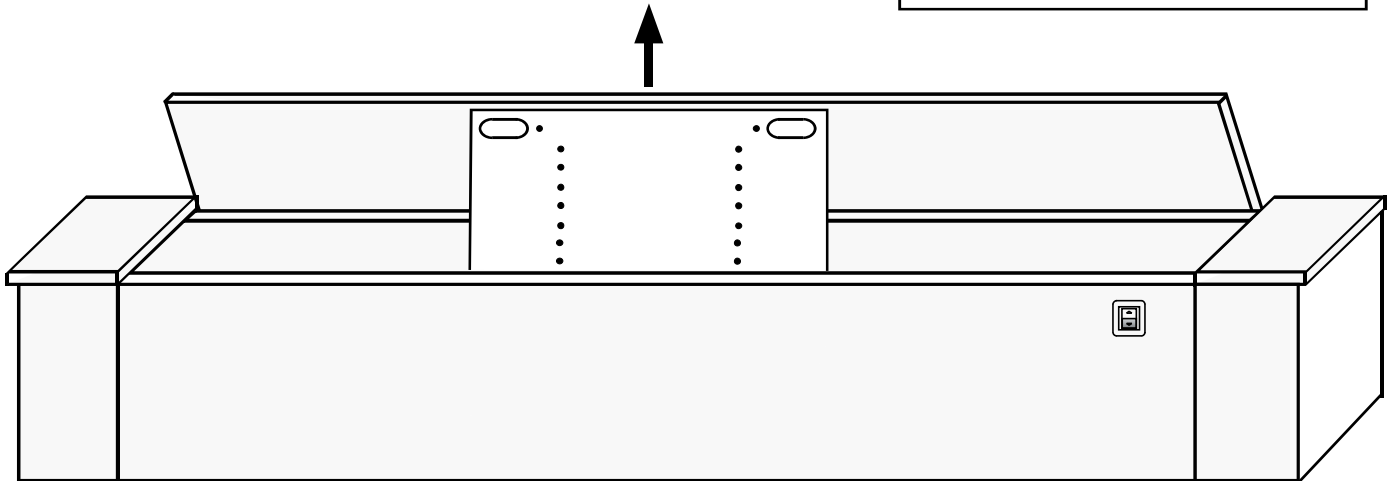
Tools Needed:
4mm Allen Wrench



Step 5:

Install the mechanism to the mechanism mounting board using the highest and lowest set of mounting holes using eight 5/8" machine screws.

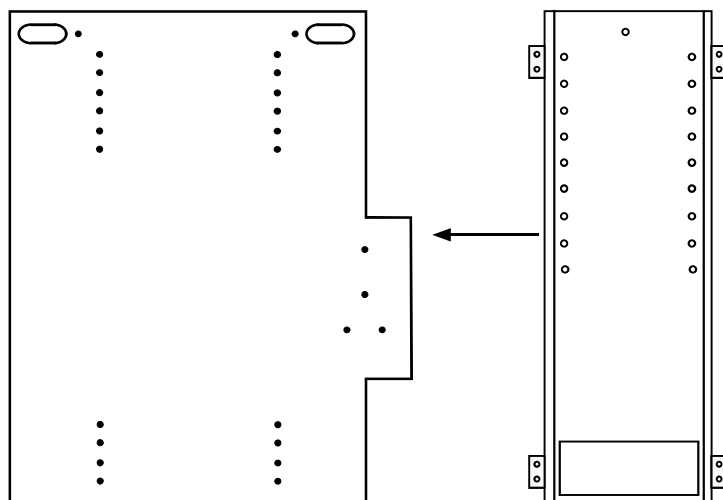

Tools Needed:



Materials:
5/8" Machine Screws

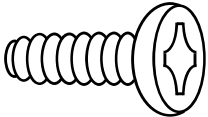

Step 6:

Secure power box to mounting board using mounting bracket and 5/8" wood screws.

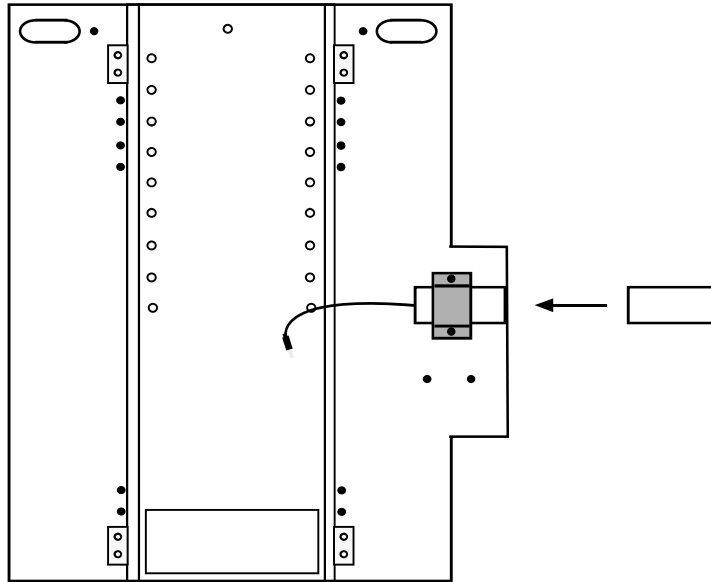

Tools Needed:

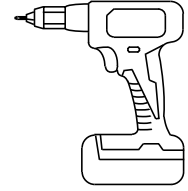

Materials Needed:
5/8" Wood Screws

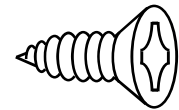

Step 7:

Plug power box into control box and mount control box to the mechanism mounting board using 1 1/4" wood screws.

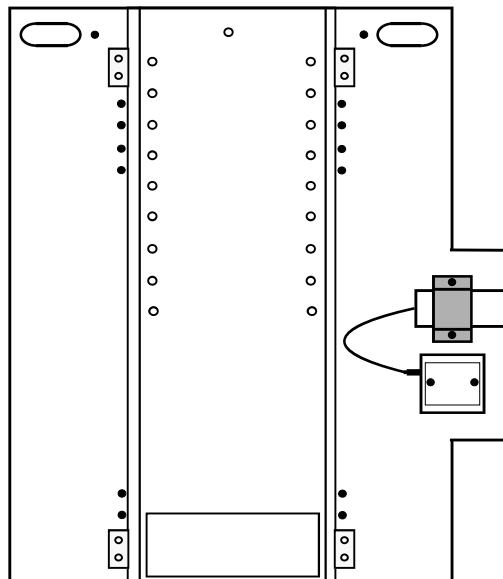

Tools Needed:

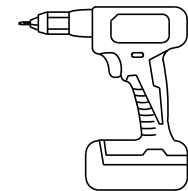

Materials Needed:
1 1/4" Machine Screws

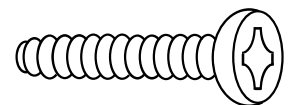

Step 8:

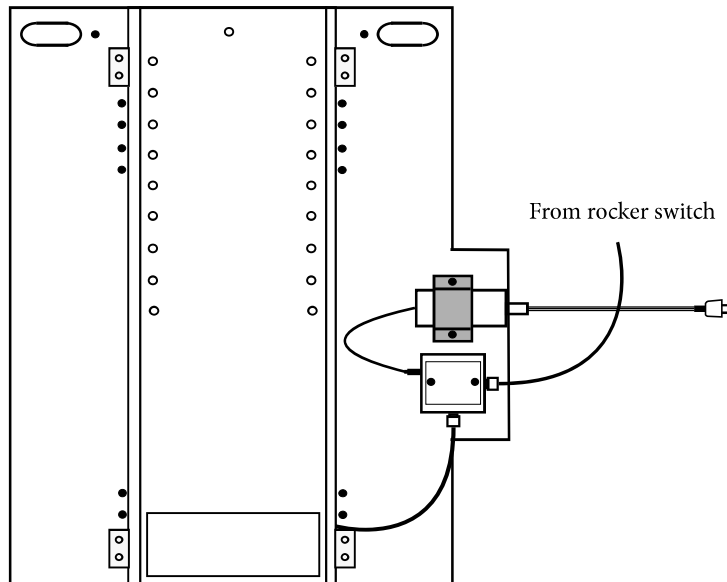

Plug the mechanism into the control box and attach power cable to the power box. While standing the mounting board near the footboard, plug the rocker switch (mounted in the footboard) to the control box.



Step 9:

Lower mechanism mounting board back into footboard, using internal footboard brackets to get properly aligned. Re-secure using 4mm allen wrench and machine screws. Please note that because the mounting board is fairly heavy, we suggest using a helper for the part of the process.

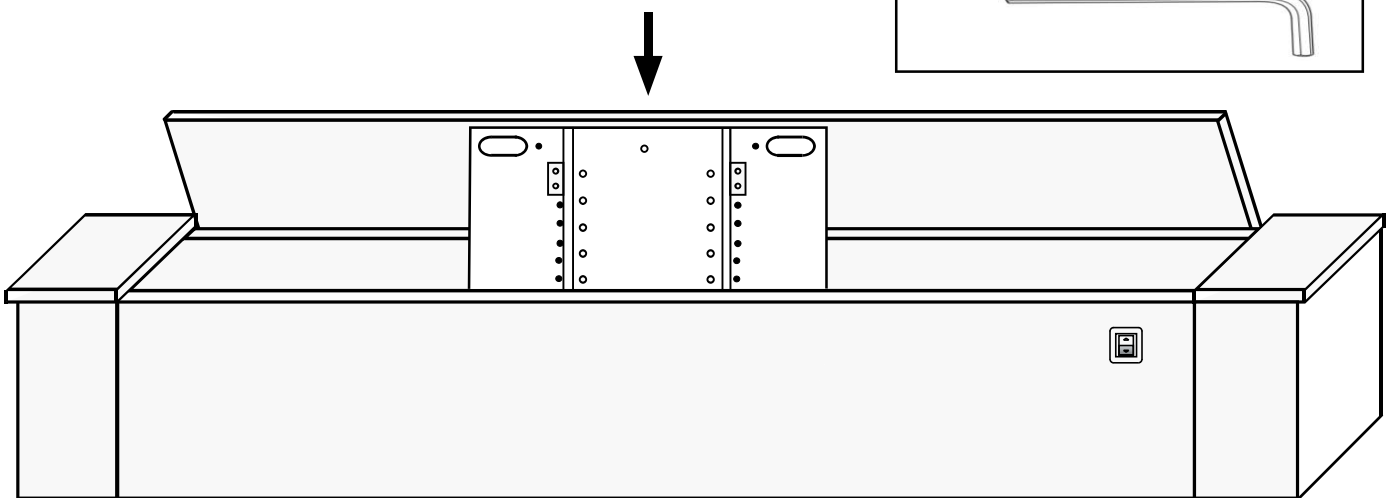
Tools Needed:
4mm Allen Wrench



— Mounting Your TV —

This process may be different for every TV make, size, model, or year. If you did NOT order a TV from Wildwood TV Lift Furniture, please visit www.wildwoodtvliftfurniture.com/will-my-tv-work to ensure that your TV will work with our TV lift mechanism.

Step 1:

First, plug the TV lift mechanism in. To do this, pull the cord out the back of the TV lift footboard and plug it in with an extension cord.

Next, using the remote (or the rocker switch located on the back of the footboard), elevate the mechanism fully. Please note that if the mechanism does not respond when using the remote, the remote and receiver may need to be re-synced. Please refer to the mechanism manufacturer's detailed instructions for more information on this process.

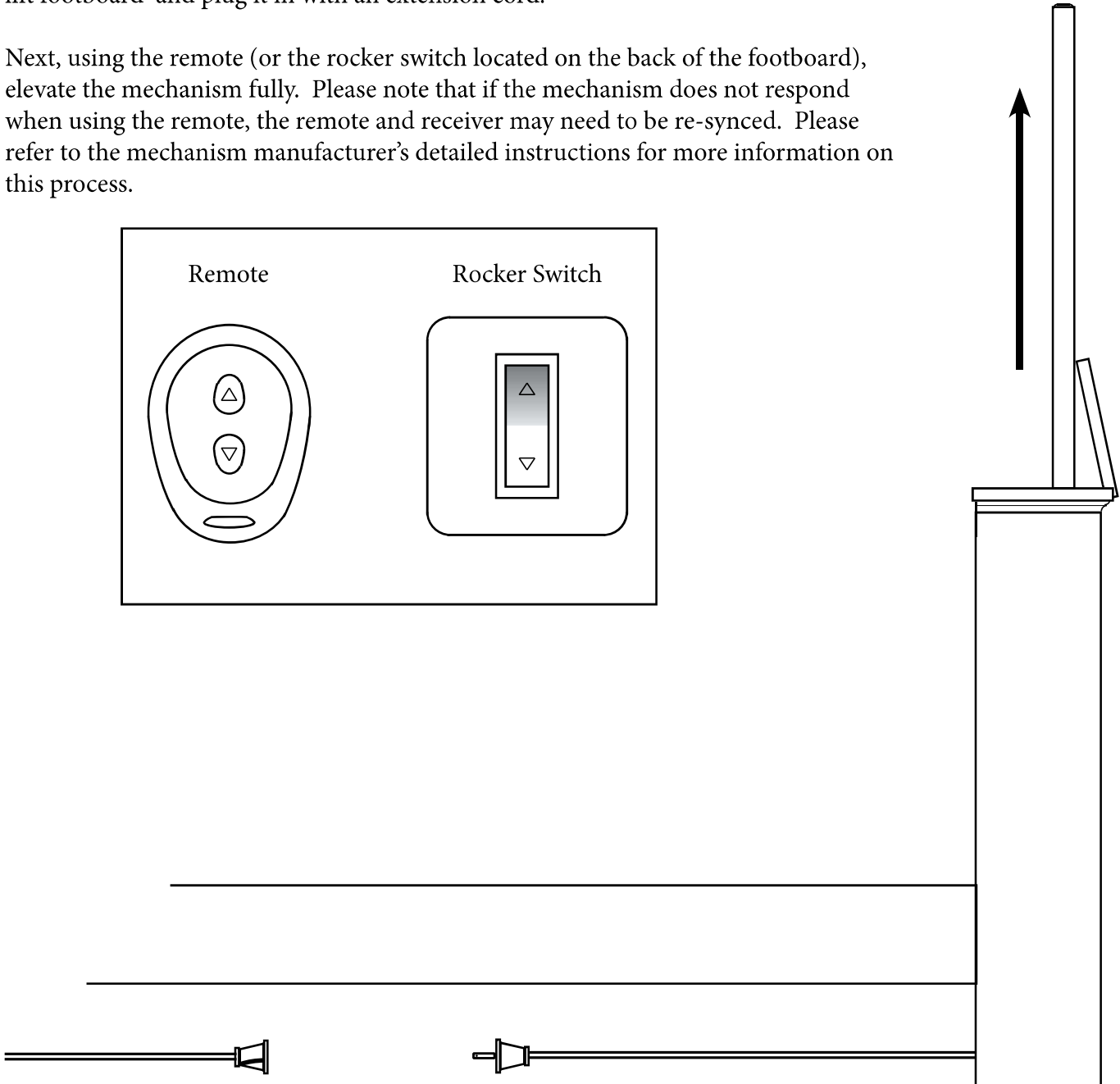
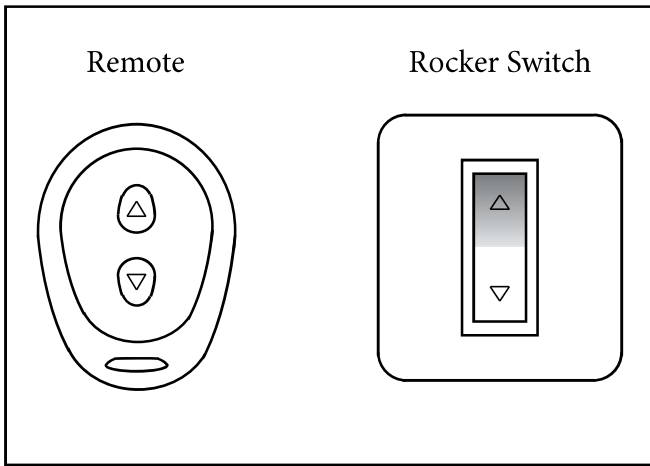

Plug TV lift mechanism in.

Step 10: Mounting The TV

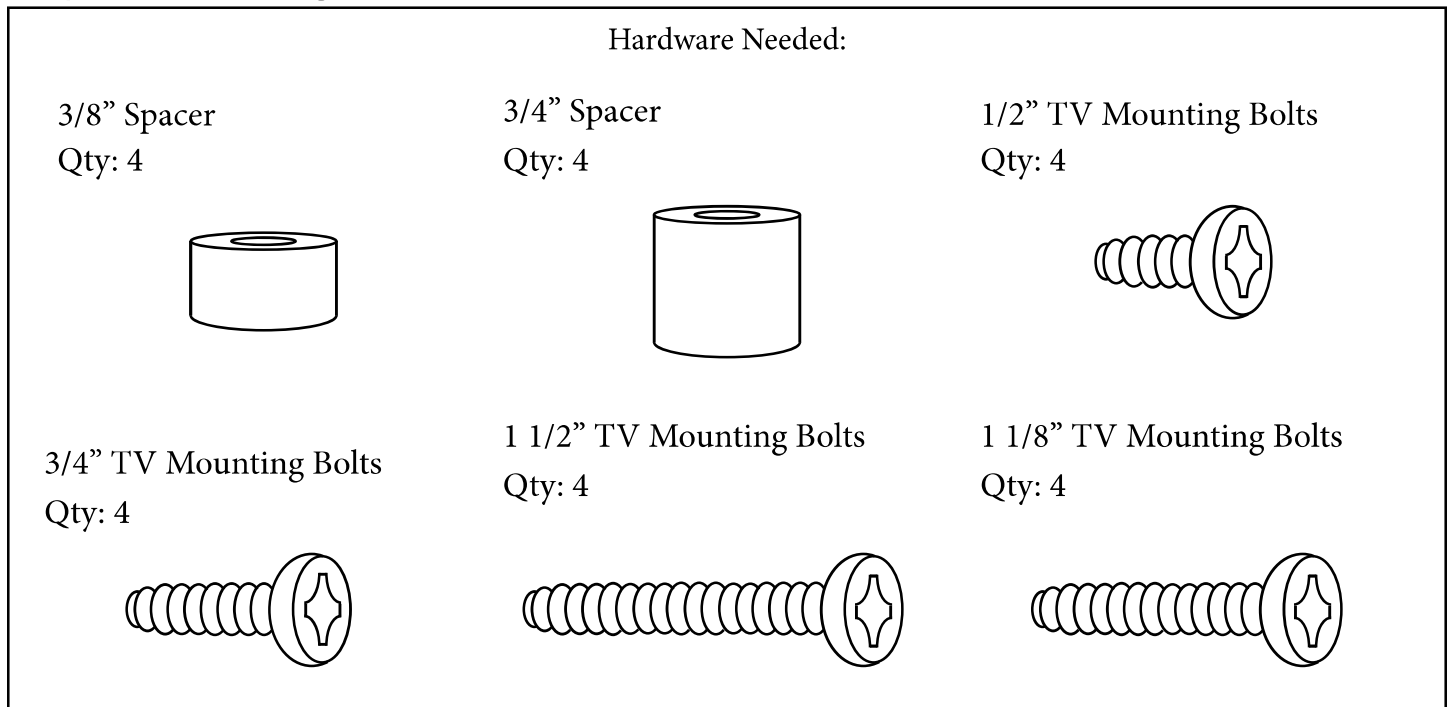

This process varies with different TV makes, sizes, and models, but if the following process will not work for your TV, feel free to give us a call to discuss a unique situation. For a detailed step-by-step guide to mounting a TV to a deluxe mechanism, see our installation video at the following link:

<https://www.youtube.com/watch?v=863wlqxYwC0&feature=youtu.be>

1. Find the 4 mounting holes on the back of your TV
2. Test the different mounting bolts to find the correct size (including length) for your TV
3. Have a helper hold the TV up against the mechanism the way that it will be positioned finally. The TV should be positioned as high on the mechanism as possible while still allowing the TV footboard's lid to close fully. Note that if the TV extends above the top of the mechanism by more than 1/2", the lid will not fully close.
4. If your TV has a protuberance that will not allow it to mount flat against the mechanism, use one of the spacers to ensure that the TV is mounted flat
 - ** If the holes on your TV will not align with the holes on the mechanism, you may need to use the mounting arms provided. In that case, simply mount the arms to the TV first, and then mount the arms to the mechanism body.

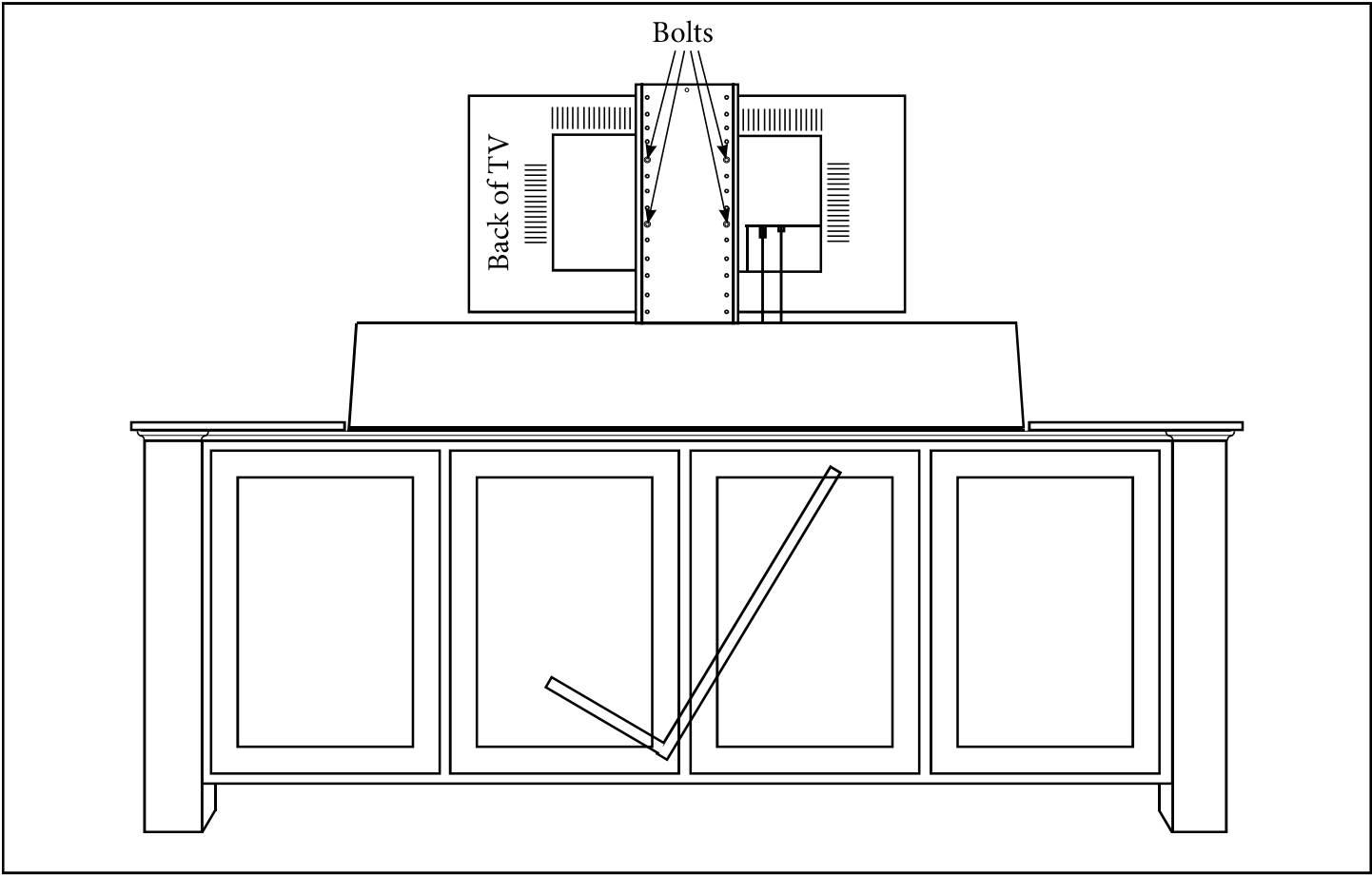

Use spacers to ensure that the TV is not tilted.

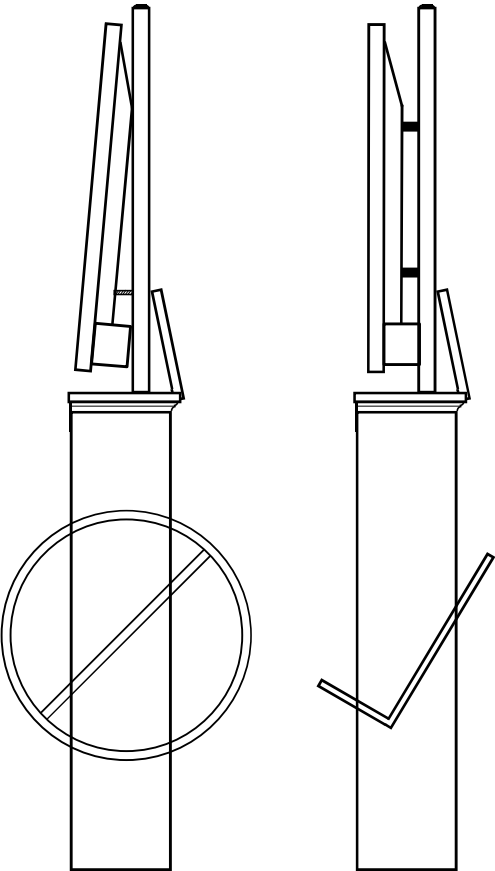

TV should be positioned as high on mechanism as possible while still allowing the lid to close fully.

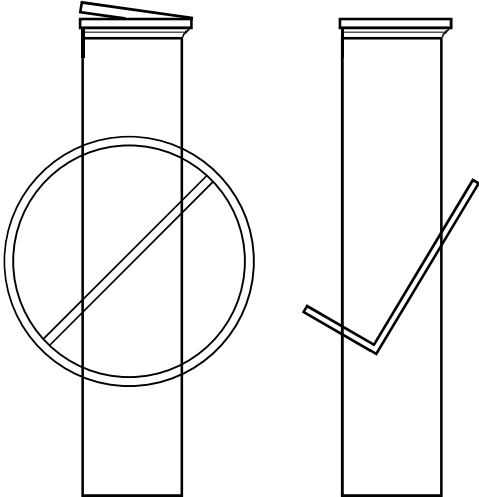

Thank you for choosing Wildwood TV Lift Furniture. We hope that you will love your TV Bed for years to come!

If you have any questions, concerns, or you need assistance with assembling your bed, call us at (801) 754-4039 or email us at contact@wildwoodtvliftfurniture.com.

We'd love to hear from you



[@wildwoodtvliftfurniture.com](https://www.facebook.com/wildwoodtvliftfurniture)



www.wildwoodtvliftfurniture.com



(801) 754-4039



contact@wildwoodtvliftfurniture.com